

**FLEXFORM**

MADE IN ITALY



**ROMEO ANTONIO CITTERIO 2019**

**DIVANI | DIVANI COMPONENTI | POUF SOFAS | SECTIONAL SOFAS | OTTOMANS**

---

**FLEXFORM** Spa

Via Einaudi 23/25 20821 Meda (MB) Italy | Tel. +39 0362 3991 | Fax +39 0362 399228 | [info@flexform.it](mailto:info@flexform.it) | [www.flexform.it](http://www.flexform.it)

---

## ROMEO | ANTONIO CITTERIO | 2019

**TIPOLOGIE** DIVANI/DIVANI componibili/POUF

**PRODOTTO** DIVANO/DIVANO componibile/POUF

**STRUTTURA** IN METALLO CON MATERASSINO IN POLIURETANO ESPANSO RIVESTITA CON MATERIALE PROTETTIVO

**CUSCINI SEDUTA** IN PIUMA D'OCA STERILIZZATA (CERTIFICATA ASSOPIUMA, ETICHETTA ORO) CON INSERTO IN MATERIALE INDEFORMABILE A DENSITÀ DIFFERENZIATA

**SCHIENALE/BRACCIOLO** IN METALLO CON IMBOTTITURA IN POLIURETANO ESPANSO E PIUMA D'OCA STERILIZZATA (CERTIFICATA ASSOPIUMA, ETICHETTA ORO)

**CUSCINI SCHIENALE** IN PIUMA D'OCA STERILIZZATA (CERTIFICATA ASSOPIUMA, ETICHETTA ORO) DA CM 75X75 CON RULLO

**CUSCINI SCHIENALE/CUSCINI OPTIONAL** IN PIUMA D'OCA STERILIZZATA (CERTIFICATA ASSOPIUMA, ETICHETTA ORO) A RICHIESTA CON SUPPLEMENTO DI PREZZO

**PIEDI** IN ALLUMINIO PRESSOFUSO NELLE FINITURE SATINATO, CROMATO, CROMO NERO, BRUNITO, CHAMPAGNE.

APPOGGIO A TERRA SU PUNTALI IN MATERIALE TERMOPLASTICO

**RIVESTIMENTO** SFODERABILE SIA NELLA VERSIONE IN TESSUTO CHE NELLA VERSIONE IN PELLE.

**LE MISURE DI INGOMBRO DI BRACCIOLO E SCHIENALE SONO DA CONSIDERARSI INDICATIVE**

**CATEGORIES** SOFAS/SECTIONAL SOFAS/OTTOMANS

**PRODUCT** SOFA/ SECTIONAL SOFA/OTTOMAN

**STRUCTURE** IN METAL WITH SOFT TOPPER IN POLYURETHANE FOAM COVERED WITH A PROTECTIVE LAMINATED FABRIC

**SEAT CUSHIONS** IN STERILIZED GOOSE DOWN (ASSOPIUMA CERTIFIED, GOLD LABEL) WITH INSERT IN CRUSHPROOF, VARIABLE DENSITY MATERIAL

**BACKREST/ARMREST** IN METAL WITH POLYURETHANE FOAM AND STERILIZED GOOSE DOWN (ASSOPIUMA CERTIFIED, GOLD LABEL) PADDING

**BACKREST CUSHIONS** 75X75 CM IN STERILIZED GOOSE DOWN (ASSOPIUMA CERTIFIED, GOLD LABEL) WITH BOLSTER

**BACKREST CUSHIONS/OPTIONAL CUSHIONS** IN STERILIZED GOOSE DOWN (ASSOPIUMA CERTIFIED, GOLD LABEL) UPON REQUEST, WITH UPCHARGE

**FEET** IN CAST ALUMINUM WITH SATIN, CHROME, BLACK CHROME, BURNISHED OR CHAMPAGNE FINISH. RESTS ON PADS MADE OF THERMOPLASTIC MATERIAL

**UPHOLSTERY** IS REMOVABLE IN BOTH THE FABRIC AND LEATHER VERSIONS.

**THE OVERALL DIMENSIONS OF THE ARMREST AND BACKREST ARE INDICATIVE**

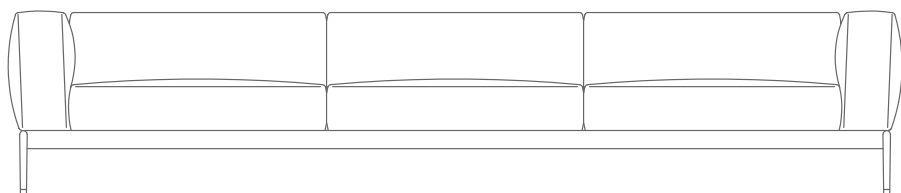





25503

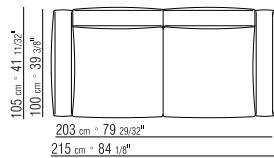
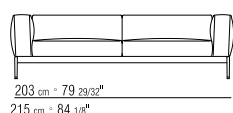
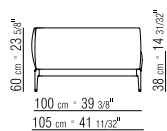

25505

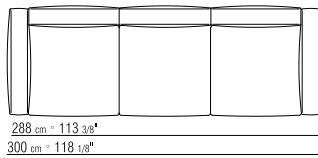
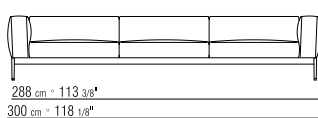

25513

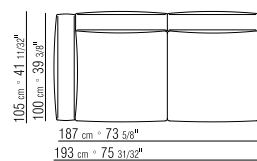
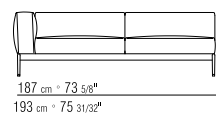
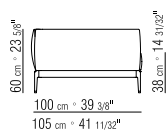

25517

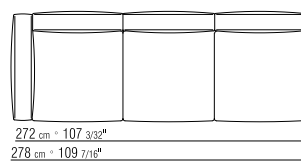
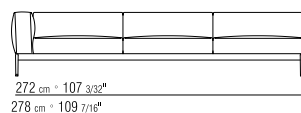

25508

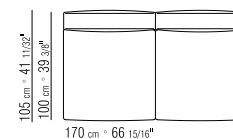
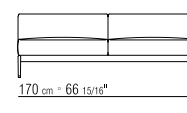
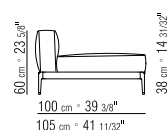

25523

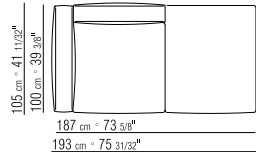
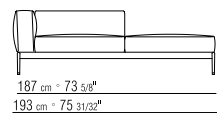
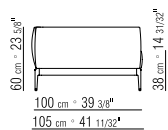

25527

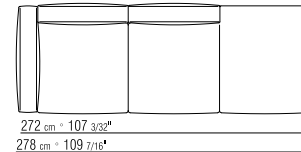
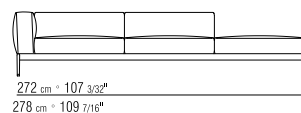

25531

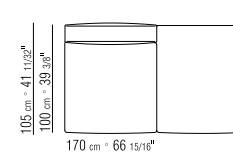
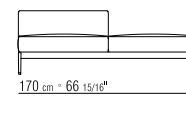
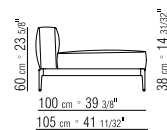

255A3

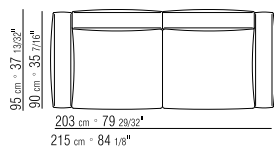
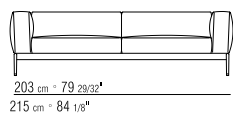
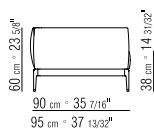

255A4

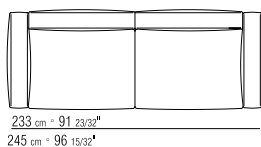
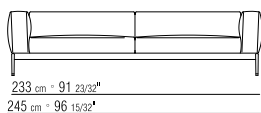

255A5

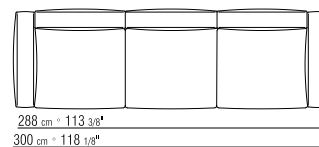
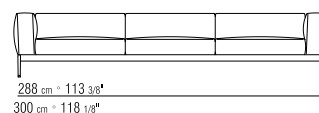

255B3

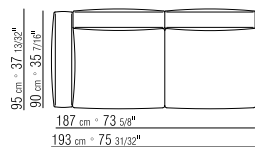
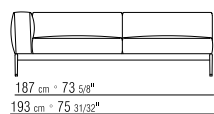
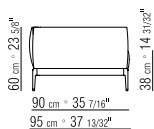

255B5

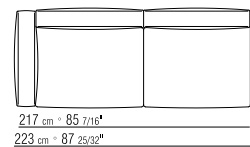
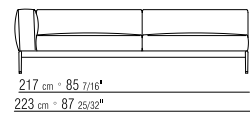

255B7

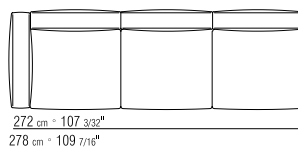
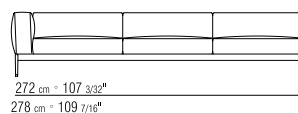

255A8

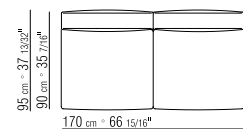
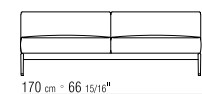
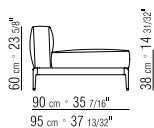

255A9

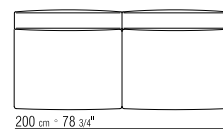
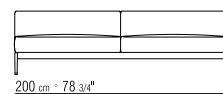

255C3

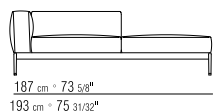
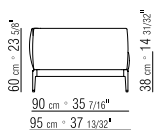

255C5

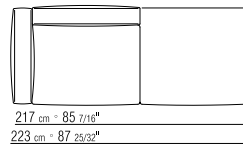
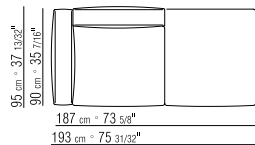
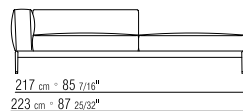

255C7

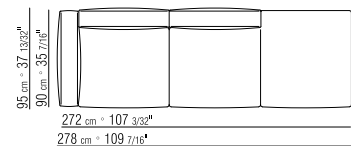
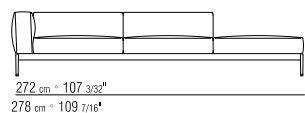
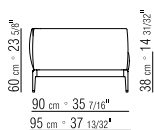

255D1

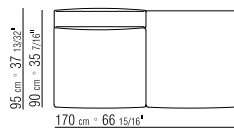
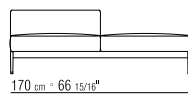
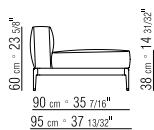

255D3

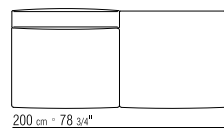
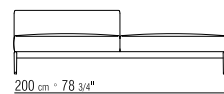

255F3

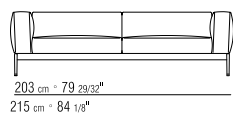
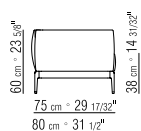

255F5

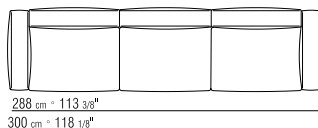
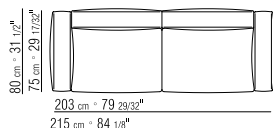
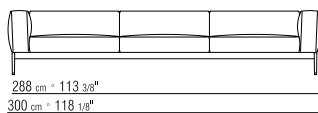

255G3

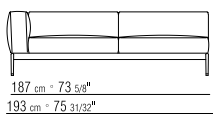
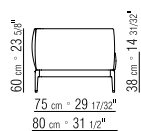

255G7

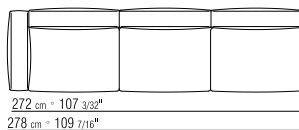
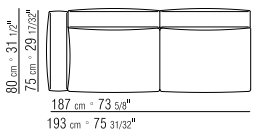

255F8

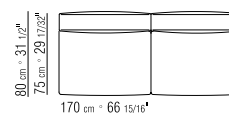
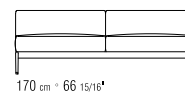
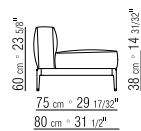

255H3

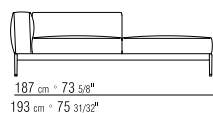
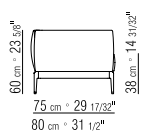

255H7

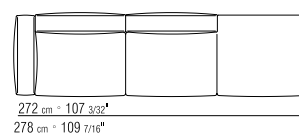
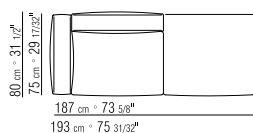
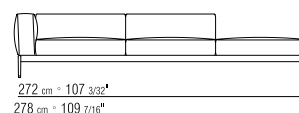

255K1

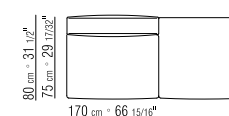
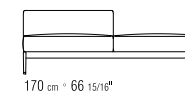
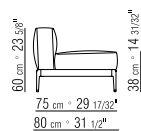



25550

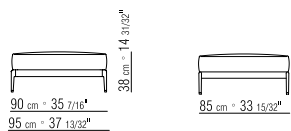

25551

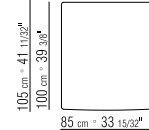
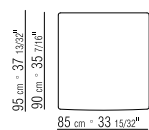
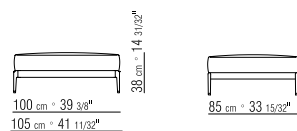

25595

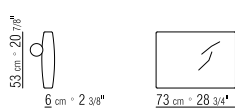

25596

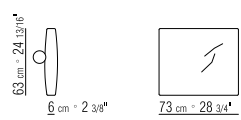

25598

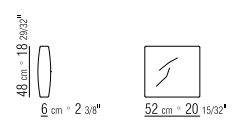

255XA

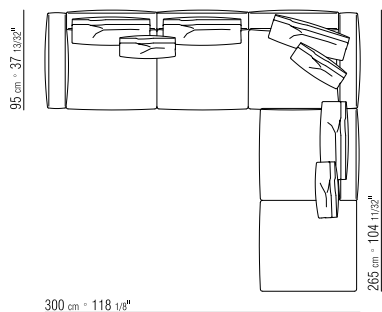

N.1 COD. 255A5 - DIVANO 300X95 CM

N.1 COD. 255D1 - ELEMENTO TERMINALE SX 170X95 CM

N.5 COD. 25596 - CUSCINO C/RULLO 73X638 CM

N.3 COD. 25598 - CUSCINO 52X48 CM

N.1 COD.255A5 - SOFA CM.300X95

N.1 COD.255D1 - END UNIT L CM.170X95

N.4 COD.25596 - CUSHION W/ROLL CM.73X63

N.3 COD.25598 - CUSHION CM.52X48

255XB

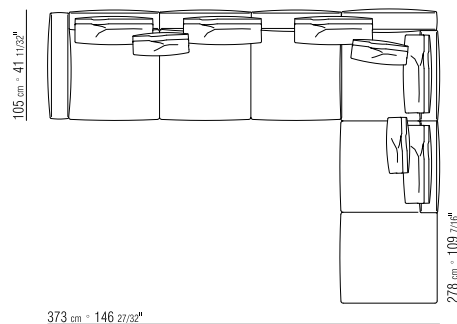

N.1 COD. 25517 - FIANCO SX 278X105 CM

N.1 COD. 255C7 - FIANCO TERMINALE SX 278X95 CM

N.5 COD. 25596 - CUSCINO C/RULLO 73X638 CM

N.3 COD. 25598 - CUSCINO 52X48 CM

N.1 COD.25517 - END UNIT L CM.278X105

N.1 COD.255C7 - LONG CORNER L CM.278X95

N.5 COD.25596 - CUSHION W/ROLL CM.73X63

N.3 COD.25598 - CUSHION CM.52X48